

ROSS GARDAM



Breeze explores the divergence of mass planar forms and the subtle light play produced.



The curved panels of Breeze interplay to create asymmetric graphic forms. Produced from plate aluminium; cut, bent and held together via three fasteners.

The Breeze Collection is presented in a variety of finishes and sizes with a repeated leg detail continuing throughout the collection.

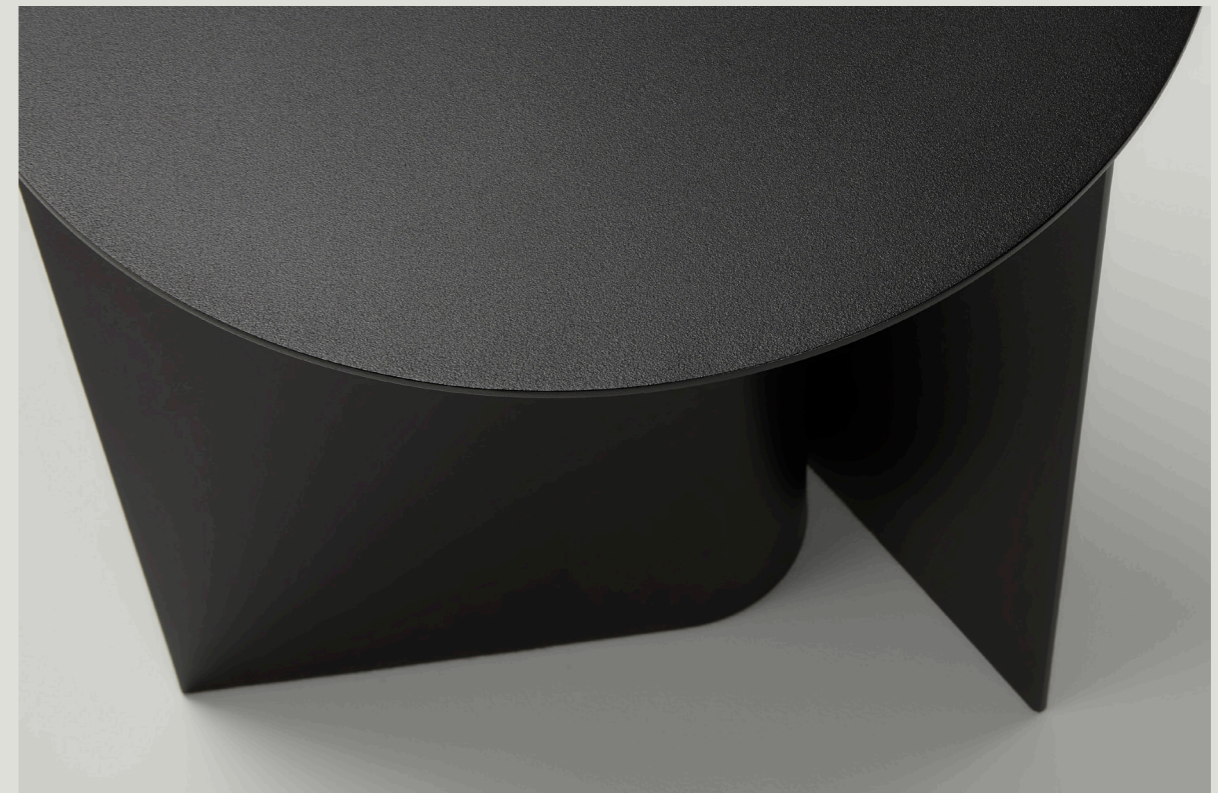





IMAGES /

LEFT / BC01 COFFEE TABLE IN TEXTURED BLACK POWDERCOAT & BRONZE MIRROR TOP

MIDDLE LEFT / BC01 COFFEE TABLE IN TEXTURED BLACK POWDERCOAT & BLACK MIRROR TOP

MIDDLE RIGHT / BC01 COFFEE TABLE IN TEXTURED BLACK POWDERCOAT & AUSTRALIAN EMPERADOR MARBLE TOP

RIGHT / BC01 COFFEE TABLE IN TEXTURED BLACK POWDERCOAT



IMAGES /

TOP LEFT / RIGHT - BS01 SIDE TABLE IN TEXTURA DEEP OCEAN / TEXTURA PAPERBARK POWDER COAT

BOTTOM LEFT / RIGHT - BS01 SIDE TABLE IN PALE EUCALYPT / MANOR RED POWDERCOAT

LEFT / BS01 SIDE TABLE IN DEEP BRONZE POWDERCOAT



IMAGES /

LEFT / BC01 COFFEE TABLE IN TEXTURED BLACK POWDERCOAT & AUSTRALIAN EMPERADOR MARBLE TOP

MIDDLE / BC01 COFFEE TABLE IN TEXTURED BLACK POWDERCOAT

RIGHT / BC01 COFFEE TABLE IN TEXTURED BLACK POWDERCOAT & BRONZE MIRROR TOP







IMAGES /

BC02 COFFEE TABLE IN TEXTURED BLACK POWDERCOAT & AUSTRALIAN
EMPERADOR MARBLE TOP AT VARIOUS DIFFERENT ANGLES



IMAGE /

ABOVE / BR01 ROUND DINING TABLE IN TEXTURED BLACK POWDERCOAT & STAINED BLACK OAK TOP

RIGHT / BR01 DETAIL

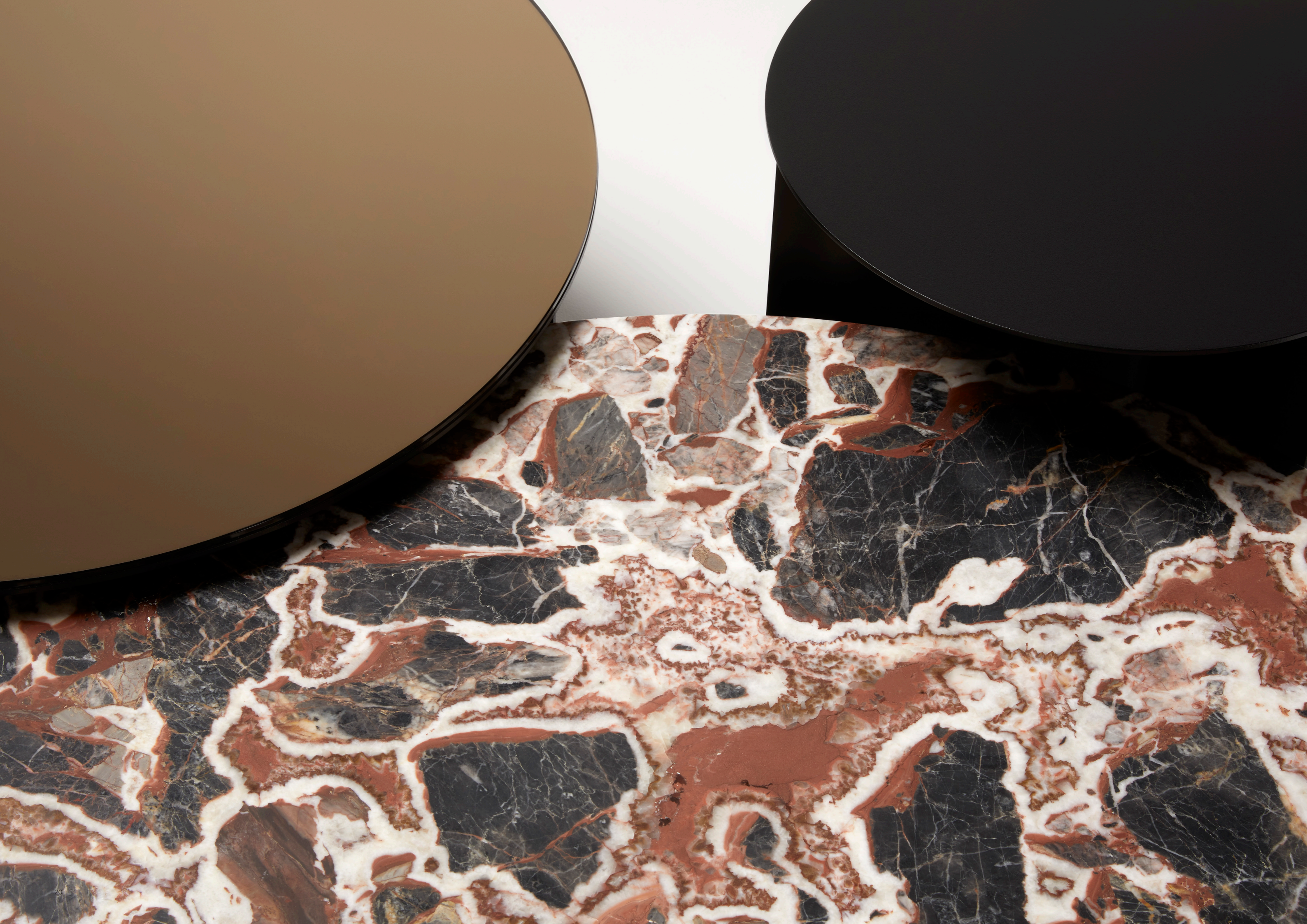

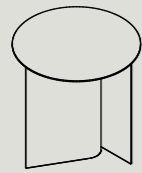

SPECIFICATIONS ⁰¹

BS01
 Ø 450
 H 450[^]

AVAILABLE IN A POWDERCOATED
 BASE WITH POWDER COATED,
 MIRROR OR MARBLE TOP.

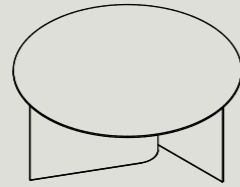

BC01
 Ø 800
 H 360[^]

AVAILABLE IN A POWDERCOATED
 BASE WITH POWDER COATED,
 MIRROR OR MARBLE TOP.

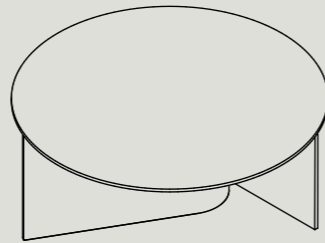

BC02
 Ø 1100
 H 300[^]

AVAILABLE IN POWDERCOATED
 BASE WITH MIRROR OR MARBLE
 TOP.



BR01
 Ø 1000 - 1200*
 H 740[^]

AVAILABLE IN A POWDERCOATED
 BASE WITH MARBLE, VENEER OR
 LAMINATE TOP.

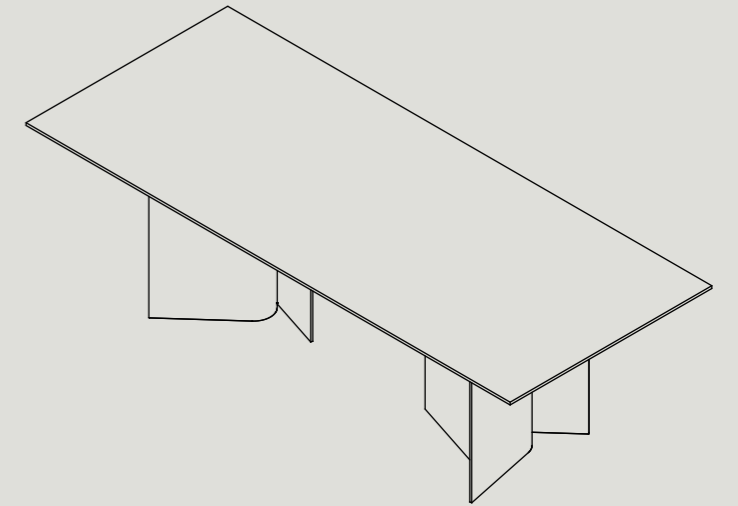

BD01
 L 2000 - 3000*
 D 800 - 1100*
 H 740[^]

AVAILABLE IN A
 POWDERCOATED*** BASE WITH
 MARBLE, VENEER OR LAMINATE
 TOP.

*Table top size range from min to max dimensions available. Custom sizing also available.

[^] Overall height with marble top +20mm & with mirror top +6mm

DINING RANGE 02

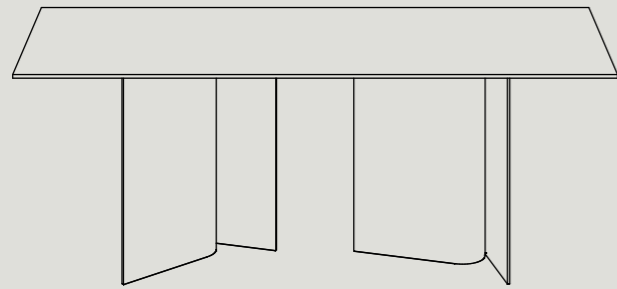

BD01.LXXXX.DXXXX
 L 2000 - 2300MM
 D 800 - 1100MM
 H 740

EACH BASE SPACED 350MM FROM TABLE EDGE (L).
 TABLE TOP AVAILABLE IN 100MM INCREMENTS IN
 THE ABOVE SPECIFIED RANGE.

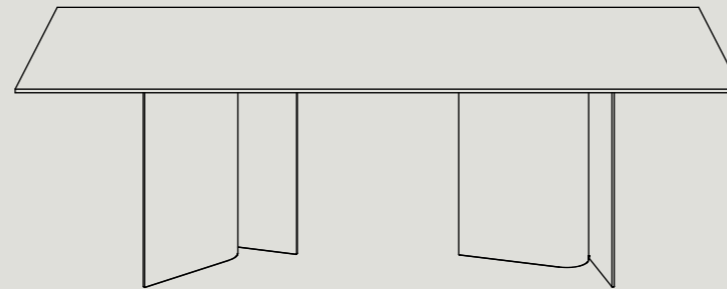

BD02.LXXXX.DXXXX
 L 2400 - 2700MM
 D 800 - 1100MM
 H 740

EACH BASE SPACED 400MM FROM TABLE EDGE (L).
 TABLE TOP AVAILABLE IN 100MM INCREMENTS IN
 THE ABOVE SPECIFIED RANGE.

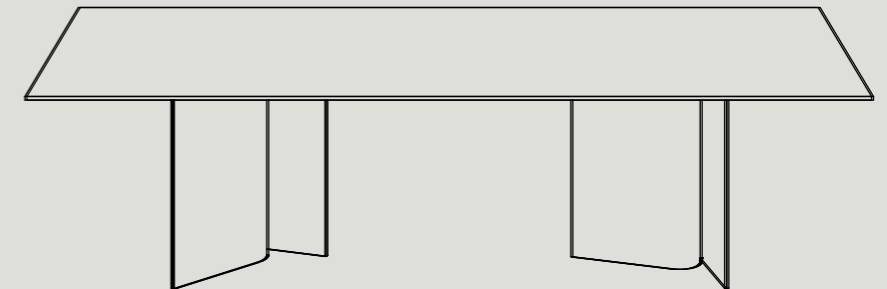

BD03.LXXXX.DXXXX
 L 2800 - 3000MM
 D 800 - 1100MM
 H 740

EACH BASE SPACED 450MM FROM TABLE EDGE (L).
 TABLE TOP AVAILABLE IN 100MM INCREMENTS IN
 THE ABOVE SPECIFIED RANGE.

DINING RANGE - WITH RAILS ⁰³

RAILS ARE TO BE USED TO SUPPORT LARGER TOPS, SIZES SPECIFIED BELOW, OR WHEN THE TOP IS SUPPLIED IN TWO PIECES. THE RAILS PROVIDE ADDITIONAL SUPPORT ACROSS THE SPAN OF THE TABLE.

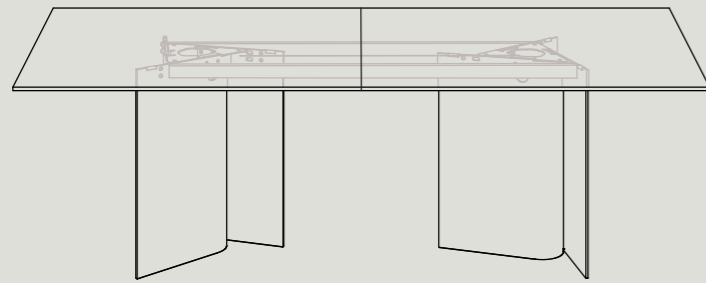

BD01-RL.LXXXX.DXXXX
L 2400 - 2700MM
D 800 - 1300MM
H 740

EACH BASE SPACED 400MM FROM TABLE EDGE (L).
TABLE TOP AVAILABLE IN 100MM INCREMENTS IN
THE ABOVE SPECIFIED RANGE.

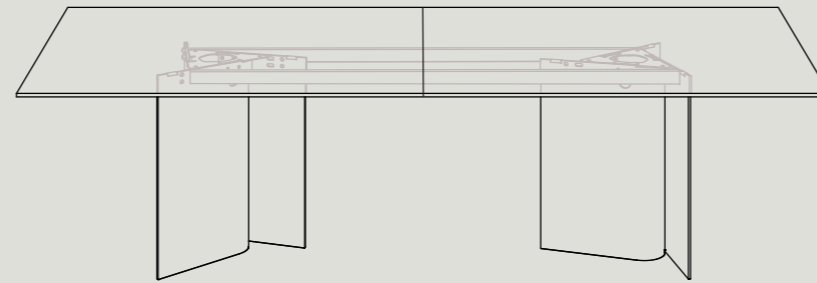

BD02-RL.LXXXX.DXXXX
L 2700 - 3100MM
D 800 - 1300MM
H 740

EACH BASE SPACED 450MM FROM TABLE EDGE (L).
TABLE TOP AVAILABLE IN 100MM INCREMENTS IN
THE ABOVE SPECIFIED RANGE.

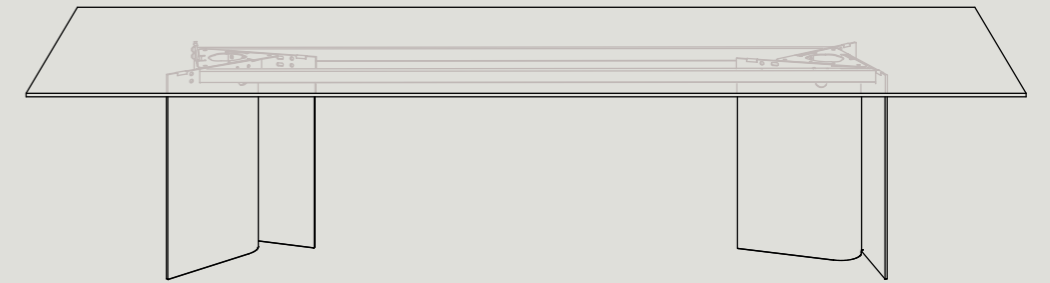

BD03-RL.LXXXX.DXXXX
L 3100 - 3600MM
D 800 - 1300MM
H 740

EACH BASE SPACED 500MM FROM TABLE EDGE (L).
TABLE TOP AVAILABLE IN 100MM INCREMENTS IN
THE ABOVE SPECIFIED RANGE.

CUSTOMIZATION ⁰⁴

FEATURES ⁰⁵

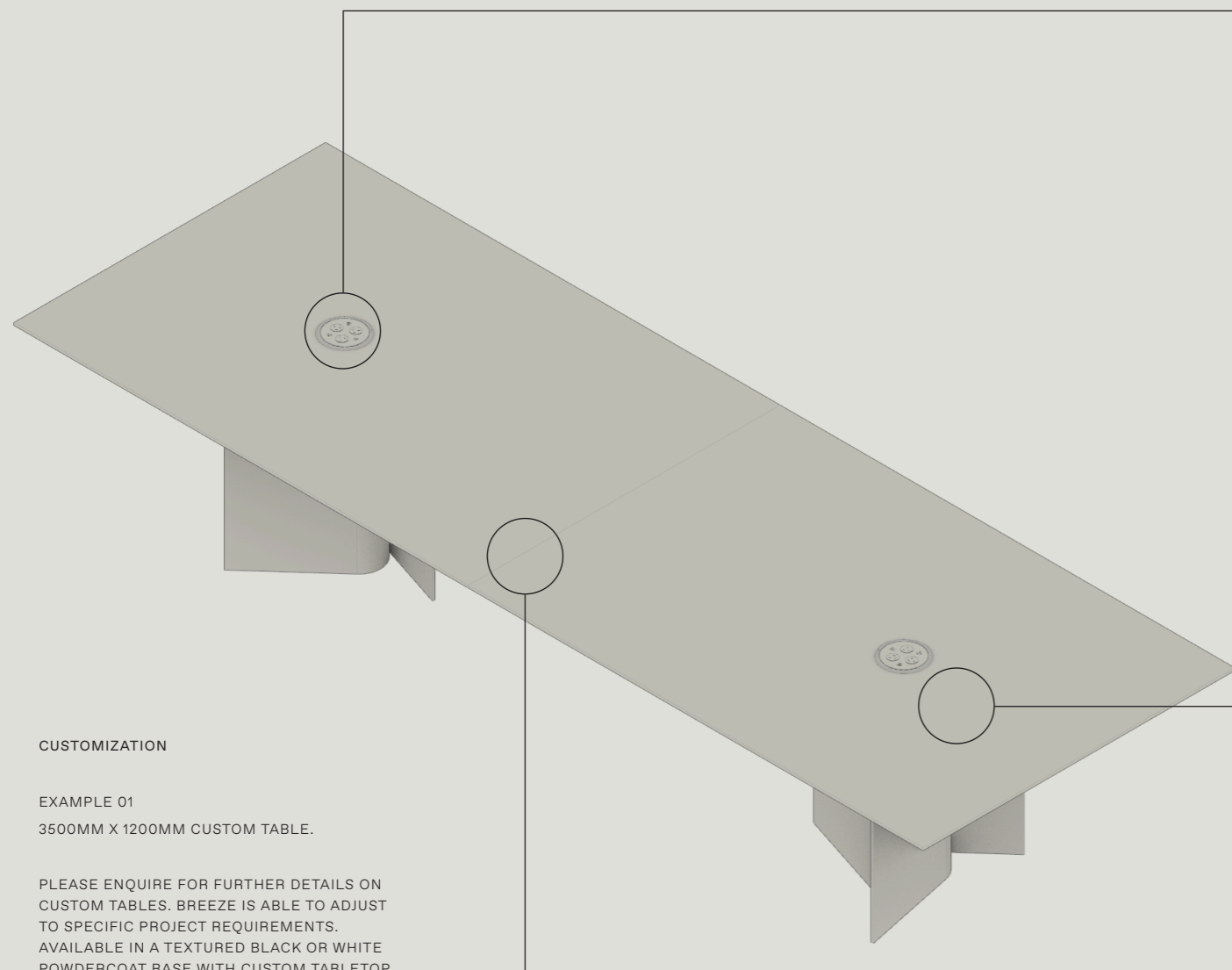

CUSTOMIZATION

EXAMPLE 01
3500MM X 1200MM CUSTOM TABLE.

PLEASE ENQUIRE FOR FURTHER DETAILS ON CUSTOM TABLES. BREEZE IS ABLE TO ADJUST TO SPECIFIC PROJECT REQUIREMENTS. AVAILABLE IN A TEXTURED BLACK OR WHITE POWDERCOAT BASE WITH CUSTOM TABLETOP.

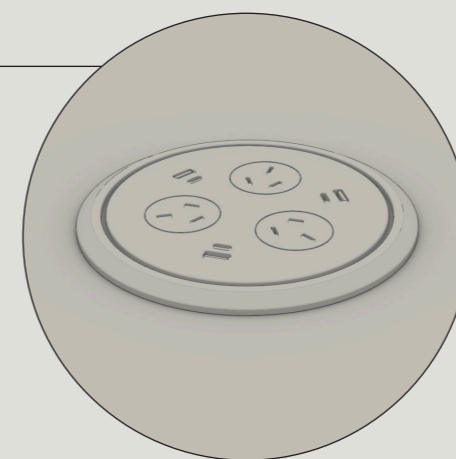

POWER

POWER UNITS CAN BE INTEGRATED INTO VARIOUS LOCATIONS OF THE TABLETOP TO POWER ELECTRONIC DEVICES. ENQUIRE WITH THE STUDIO TO CHECK WHAT POWER UNITS ARE COMPATIBLE WITH THE BREEZE COLLECTION.

*POWER INTEGRATION ONLY AVAILABLE FOR BREEZE DINING (BD01), ROUND (BR01) AND CUSTOM DINING TABLES.

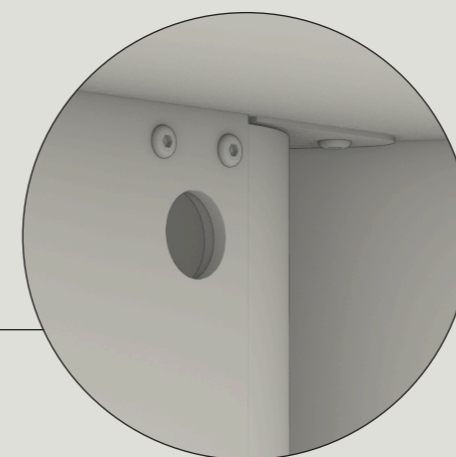

CABLE MANAGEMENT

THE UNDERSIDE OF THE DINING TABLES FEATURE MULTIPLE CABLE MANAGEMENT SLOTS TO KEEP ANY POWER INTEGRATION CLEAN, ORGANISED AND HIDDEN. THE CUT-OUTS ARE THE APPROPRIATE SIZE TO FED A STANDARD AUS PLUG THROUGH.

HIDDEN ENTRY POINTS AT THE BOTTOM OF EACH BASE ALLOW FOR EXTERNAL POWER TO SEAMLESSLY ENTER THE TABLE. ALTERNATIVELY, A FLOOR POWER BOX CAN BE CONCEALED WITHIN THE CENTRAL VOID OF THE BASE.

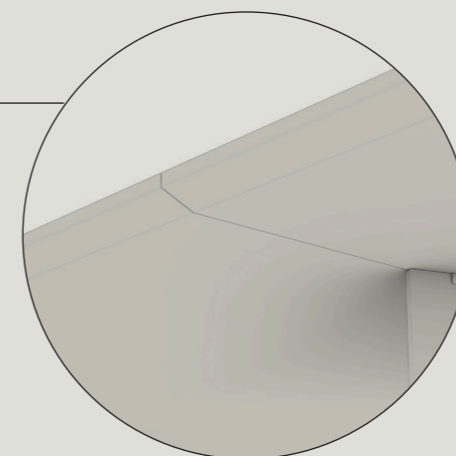

DETAILING

STANDARD TABLETOPS COME SUPPLIED WITH A SHARK-NOSE EDGE DETAIL AS SHOWN. ALTERNATIVE EDGING AVAILABLE UPON REQUEST. TABLETOP SHAPES AND MATERIALS ARE ALL OPTIONAL CUSTOMIZATIONS.



TECHNICAL⁰⁶

AVAILABLE FINISHES

SIDE & COFFEE TABLE



ROUND & DINING TABLE

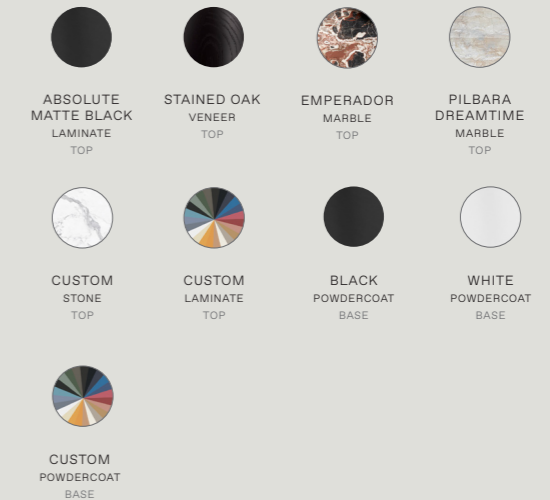

MATERIALS

SIDE & COFFEE TABLES

BASE / The base system is constructed with aluminium plate then finished with a durable powdercoat.

TOP / The top is constructed with aluminium plate then finished with a durable powdercoat. An optional mirror or marble top is also available. Note - 1100DIA Coffee Table must be supplied with a mirror or marble top.

DINING TABLE

BASE / The base system is constructed in aluminium plate then finished with a durable powdercoat.

TOP / The top is available in a variety of finishes as noted above. Stone tops are supplied with an underside substrate that mechanically fastens to the base. Timber/Laminate tops are fastened directly to the base.

POWER & CUSTOMISATION

POWER

Available for integration within the Dining (BD01), Round (BR01) and custom tables, there are various options to mount power boxes, USB & wireless charging hubs. These units can be positioned directly above the base locations or central on a Dining tabletop. Cables can be hidden within the base, cable exits are located at the top and bottom of each base for tidy cable management.

CUSTOMISATION

The Breeze Dining Table can be modified to suit long-spanning spaces, please enquire with the studio for further information. Power integration also available with custom configurations.

OUTDOOR USE

The Breeze collection is optionally available for outdoor use. Please note, Breeze Dining and Round tables, this is only available with stone tops.



PHOTOGRAPHY BY HAYDN CATTACH - HAYDNCATTACH.COM
COLOUR AND SWATCHES SHOWN IN THIS DOCUMENT ARE FOR REFERENCE ONLY AND MAY DIFFER IN ACTUALITY.
COPYRIGHT ©2024 ROSS GARDAM PTY LTD. ALL CONCEPTS, PHOTOGRAPHY AND IDEAS CONTAINED WITHIN THIS DOCUMENT ARE PRIVATE AND CONFIDENTIAL. THEY MUST NOT BE REPRODUCED IN ANY WAY OR FORM AND REMAIN THE INTELLECTUAL PROPERTY OF ROSS GARDAM. ALL PRODUCTS ARE REGISTERED DESIGNS WITH IP AUSTRALIA.